

# COCOON

Design Giuseppe Viganò

## STANDARD FEATURES

- METAL FRAME AND BASE AVAILABLE IN:  
CHROME, DARK CHROME-TITANIO, BURNISHED ALUMINIUM, BURNISHED COPPER OR PAINTED METAL

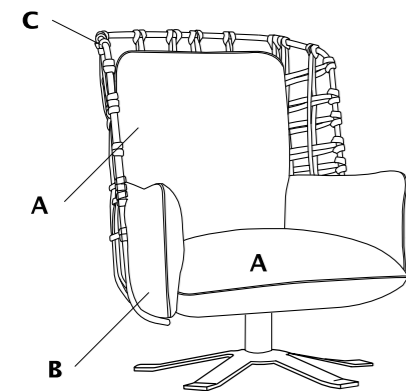

# GEM

Design Giuseppe Viganò

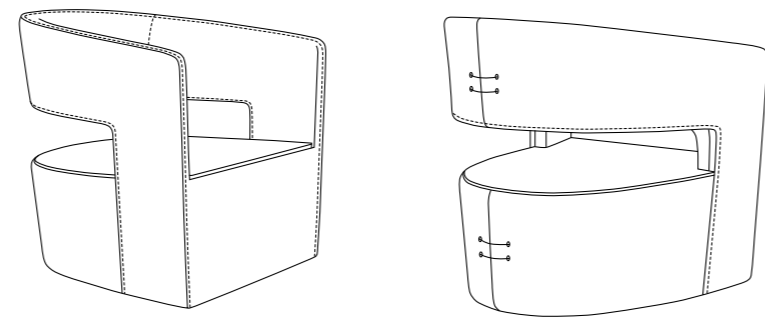

# LOVE

Design Giuseppe Viganò

## STANDARD FEATURES

- METAL FRAME AVAILABLE IN:  
CHROME, DARK CHROME-TITANIO, BURNISHED ALUMINIUM, BURNISHED COPPER OR PAINTED METAL

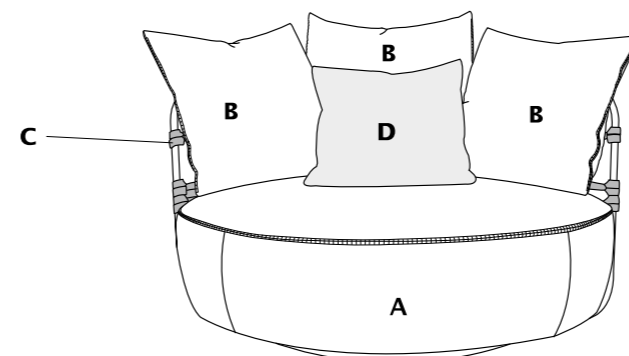

# SCARLETT

Design Giuseppe Viganò

## STANDARD FEATURES

- STEEL STRUCTURE, PADDED WITH MOULDED POLYURETHANE FOAM AND COVERED WITH A THIN FEATHER LINING  
- METAL LEGS AVAILABLE IN:  
CHROME, DARK CHROME-TITANIO, BURNISHED ALUMINIUM, BURNISHED COPPER OR PAINTED METAL

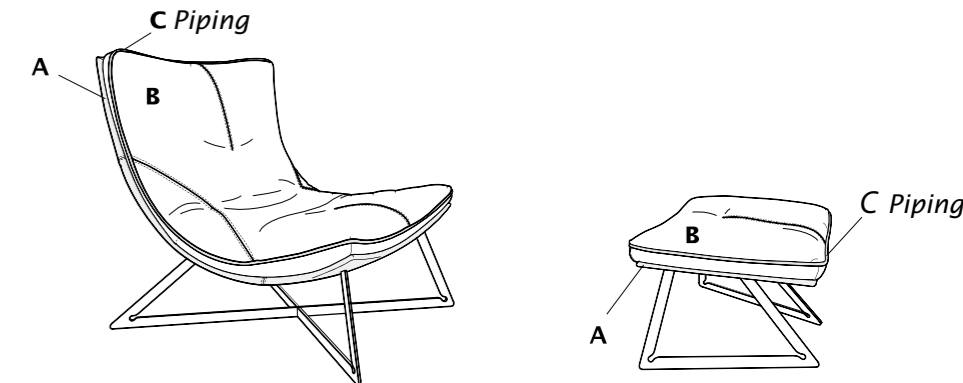

**POL**  
(swivel)

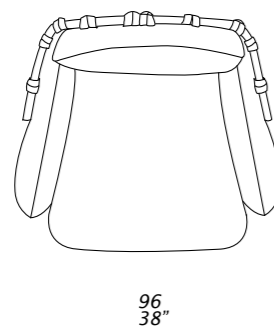
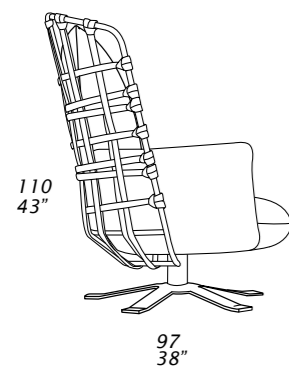

**POL**  
(swivel)

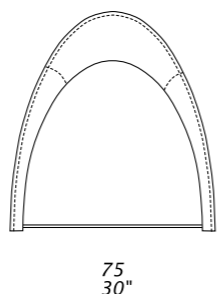
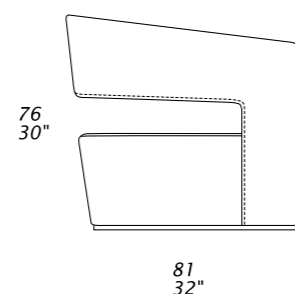

**PNA**

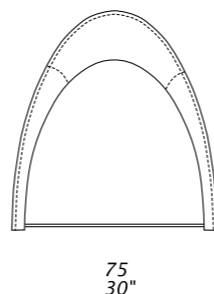
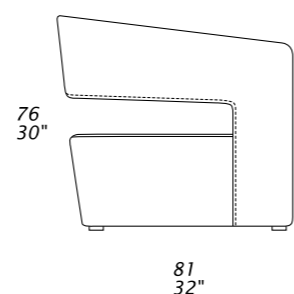

**POL**  
(swivel)

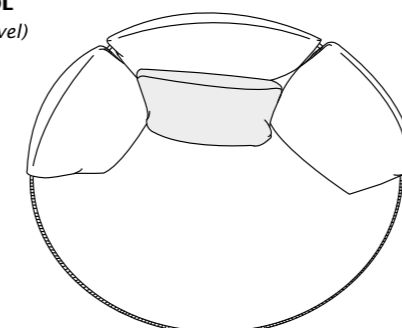
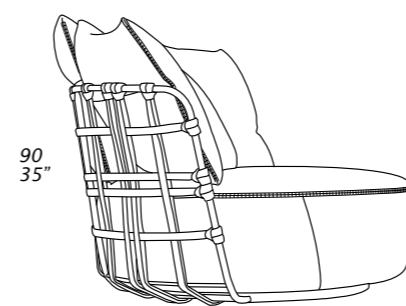

120  
47"

140  
55"

**C11**  
suggested pillow

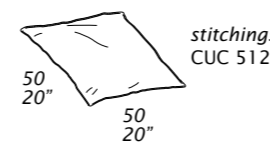

50  
20"

50  
20"

stitchings  
CUC 512

**C0110**  
suggested pillow

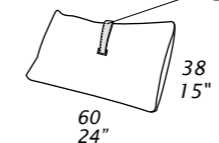

38  
15"

60  
24"

C

**CHS**

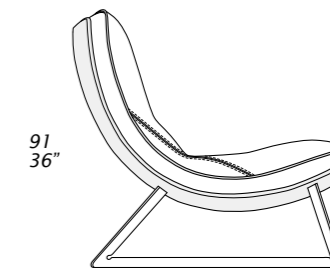

91  
36"

98  
39"

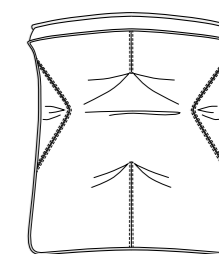

82  
32"

**EV2**

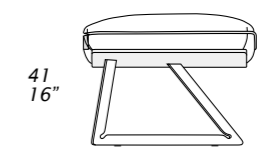

41  
16"

57  
22"

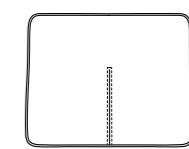

72  
28"

**PG013**  
suggested headrest

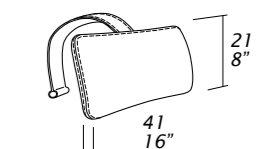

21  
8"

41  
16"

4  
2"

Dimensions: the first figure shows sizes in centimeters, the second in inches.  
Each piece is made by hand and has its own uniqueness. Measures may vary with a tolerance up to 3%.  
Seat depth 55 cm - 22".  
Seat height 43 cm - 17".

Technical sheet

Dimensions: the first figure shows sizes in centimeters, the second in inches.  
Each piece is made by hand and has its own uniqueness. Measures may vary with a tolerance up to 3%.  
Seat depth 59 cm - 23".  
Seat height 40 cm - 16".

Technical sheet

Dimensions: the first figure shows sizes in centimeters, the second in inches.  
Each piece is made by hand and has its own uniqueness. Measures may vary with a tolerance up to 3%.  
Seat depth 72 cm - 28".  
Seat height 42 cm - 17".

Technical sheet

Dimensions: the first figure shows sizes in centimeters, the second in inches.  
Each piece is made by hand and has its own uniqueness. Measures may vary with a tolerance up to 3%.  
Seat depth 58 cm - 23".  
Seat height 42 cm - 17".

Technical sheet